



# BF1207

## Dual N-channel dual gate MOSFET

Rev. 2 — 7 September 2011

Product data sheet

## 1. Product profile

---

### 1.1 General description

The BF1207 is a combination of two dual gate MOSFET amplifiers with shared source and gate2 leads and an integrated switch.

The source and substrate are interconnected. Internal bias circuits enable Direct Current (DC) stabilization and a very good cross-modulation performance during Automatic Gain Control (AGC). Integrated diodes between the gates and source protect against excessive input voltage surges. The BF1207 has a SOT363 micro-miniature plastic package.

#### CAUTION



This device is sensitive to ElectroStatic Discharge (ESD). Therefore care should be taken during transport and handling.

### 1.2 Features and benefits

- Two low noise gain controlled amplifiers in a single package. One with a fully integrated bias and one with partly integrated bias
- Internal switch to save external components
- Superior cross-modulation performance during AGC
- High forward transfer admittance
- High forward transfer admittance to input capacitance ratio

### 1.3 Applications

- Gain controlled low noise amplifiers for Very High Frequency (VHF) and Ultra High Frequency (UHF) applications with 5 V supply voltage, such as digital and analog television tuners and professional communication equipment



**1.4 Quick reference data**

**Table 1. Quick reference data**  
Per MOSFET unless otherwise specified.

Symbol	Parameter	Conditions	Min	Typ	Max	Unit
$V_{DS}$	drain-source voltage	DC	-	-	6	V
$I_D$	drain current	DC	-	-	30	mA
$P_{tot}$	total power dissipation	$T_{sp} \leq 107\text{ }^\circ\text{C}$	[1]	-	180	mW
$ y_{fs} $	forward transfer admittance	$f = 1\text{ MHz}$				
		amplifier A; $I_D = 18\text{ mA}$	25	30	40	mS
		amplifier B; $I_D = 14\text{ mA}$	26	31	41	mS
$C_{iss(G1)}$	input capacitance at gate1	$f = 100\text{ MHz}$				
		amplifier A	-	2.2	2.7	pF
		amplifier B	-	1.9	2.4	pF
$C_{rss}$	reverse transfer capacitance	$f = 100\text{ MHz}$	-	20	-	fF
NF	noise figure	amplifier A; $f = 400\text{ MHz}$	-	1.3	-	dB
		amplifier B; $f = 800\text{ MHz}$	-	1.4	-	dB
Xmod	cross-modulation	input level for $k = 1\%$ at 40 dB AGC				
		amplifier A	100	105	-	dB $\mu$ V
		amplifier B	100	103	-	dB $\mu$ V
$T_j$	junction temperature		-	-	150	$^\circ\text{C}$

[1]  $T_{sp}$  is the temperature at the soldering point of the source lead.

**2. Pinning information**

**Table 2. Discrete pinning**

Pin	Description	Simplified outline	Symbol
1	drain (AMP A)		
2	source		
3	drain (AMP B)		
4	gate1 (AMP B)		
5	gate2		
6	gate1 (AMP A)		

### 3. Ordering information

Table 3. Ordering information

Type number	Package		
	Name	Description	Version
BF1207	-	plastic surface mounted package; 6 leads	SOT363

### 4. Marking

Table 4. Marking

Type number	Marking code <sup>[1]</sup>
BF1207	M2*

- [1] \* = p: Made in Hong Kong.  
 \* = t: Made in Malaysia.  
 \* = W: Made in China.

### 5. Limiting values

Table 5. Limiting values

In accordance with the Absolute Maximum Rating System (IEC 60134).

Symbol	Parameter	Conditions	Min	Max	Unit
<b>Per MOSFET</b>					
$V_{DS}$	drain-source voltage	DC	-	6	V
$I_D$	drain current	DC	-	30	mA
$I_{G1}$	gate1 current		-	±10	mA
$I_{G2}$	gate2 current		-	±10	mA
$P_{tot}$	total power dissipation	$T_{sp} \leq 107\text{ °C}$ <sup>[1]</sup>	-	180	mW
$T_{stg}$	storage temperature		-65	+150	°C
$T_j$	junction temperature		-	150	°C

- [1]  $T_{sp}$  is the temperature at the soldering point of the source lead.

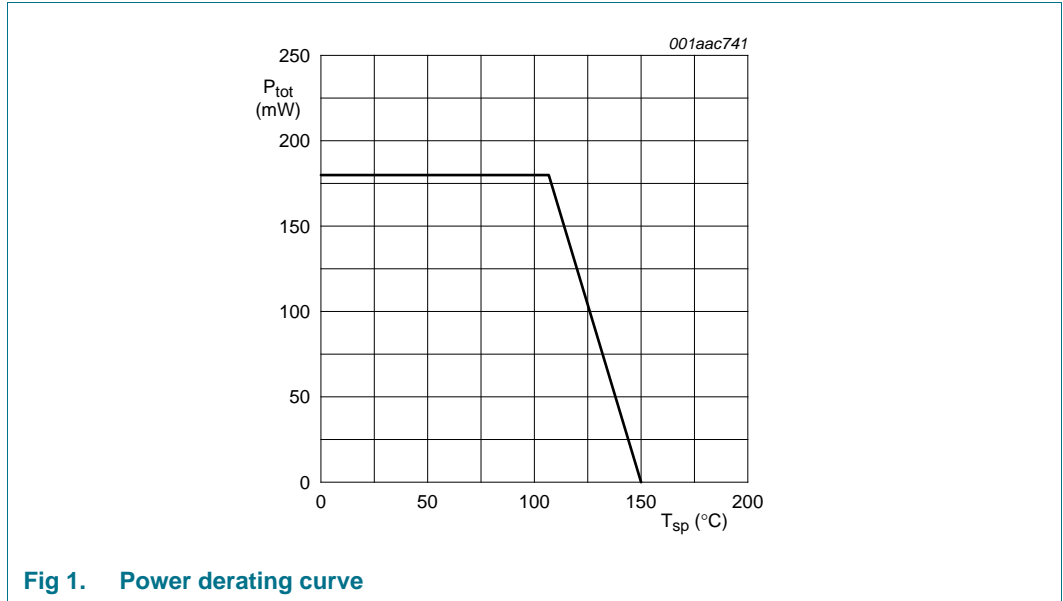

Fig 1. Power derating curve

## 6. Thermal characteristics

Table 6. Thermal characteristics

Symbol	Parameter	Conditions	Typ	Unit
R <sub>th(j-sp)</sub>	thermal resistance from junction to soldering point		240	K/W

## 7. Static characteristics

Table 7. Static characteristics

T<sub>j</sub> = 25 °C.

Symbol	Parameter	Conditions	Min	Typ	Max	Unit
<b>Per MOSFET; unless otherwise specified</b>						
V <sub>(BR)DSS</sub>	drain-source breakdown voltage	V <sub>G1-S</sub> = V <sub>G2-S</sub> = 0 V; I <sub>D</sub> = 10 μA				
		amplifier A	6	-	-	V
		amplifier B	6	-	-	V
V <sub>(BR)G1-SS</sub>	gate1-source breakdown voltage	V <sub>GS</sub> = V <sub>DS</sub> = 0 V; I <sub>G1-S</sub> = 10 mA	6	-	10	V
V <sub>(BR)G2-SS</sub>	gate2-source breakdown voltage	V <sub>GS</sub> = V <sub>DS</sub> = 0 V; I <sub>G2-S</sub> = 10 mA	6	-	10	V
V <sub>F(S-G1)</sub>	forward source-gate1 voltage	V <sub>G2-S</sub> = V <sub>DS</sub> = 0 V; I <sub>S-G1</sub> = 10 mA	0.5	-	1.5	V
V <sub>F(S-G2)</sub>	forward source-gate2 voltage	V <sub>G1-S</sub> = V <sub>DS</sub> = 0 V; I <sub>S-G2</sub> = 10 mA	0.5	-	1.5	V
V <sub>G1-S(th)</sub>	gate1-source threshold voltage	V <sub>DS</sub> = 5 V; V <sub>G2-S</sub> = 4 V; I <sub>D</sub> = 100 μA	0.3	-	1.0	V
V <sub>G2-S(th)</sub>	gate2-source threshold voltage	V <sub>DS</sub> = 5 V; V <sub>G1-S</sub> = 5 V; I <sub>D</sub> = 100 μA	0.4	-	1.0	V
I <sub>DSX</sub>	drain-source current	V <sub>G2-S</sub> = 4 V; V <sub>DS</sub> = 5 V; R <sub>G1</sub> = 68 kΩ				
		amplifier A	[1] 13	-	23	mA
		amplifier B	[2] 9	-	19	mA

**Table 7. Static characteristics ...continued**  
 $T_j = 25\text{ }^\circ\text{C}$ .

Symbol	Parameter	Conditions	Min	Typ	Max	Unit
$I_{G1-S}$	gate1 cut-off current	$V_{G2-S} = V_{DS(A)} = 0\text{ V}$				
		amplifier A; $V_{G1-S(A)} = 5\text{ V}$ ; $V_{DS(B)} = 0\text{ V}$	-	-	50	nA
		amplifier B; $V_{G1-S(A)} = 0\text{ V}$ ; $I_{D(B)} = 0\text{ A}$	-	-	50	nA
$I_{G2-S}$	gate2 cut-off current	$V_{G2-S} = 4\text{ V}$ ; $V_{G1-S} = V_{DS(A)} = V_{DS(B)} = 0\text{ V}$ ;	-	-	20	nA

- [1]  $R_{G1}$  connects gate1 (A) to  $V_{GG} = 5\text{ V}$  (see [Figure 3](#)).
- [2]  $R_{G1}$  connects gate1 (B) to  $V_{GG} = 0\text{ V}$  (see [Figure 3](#)).

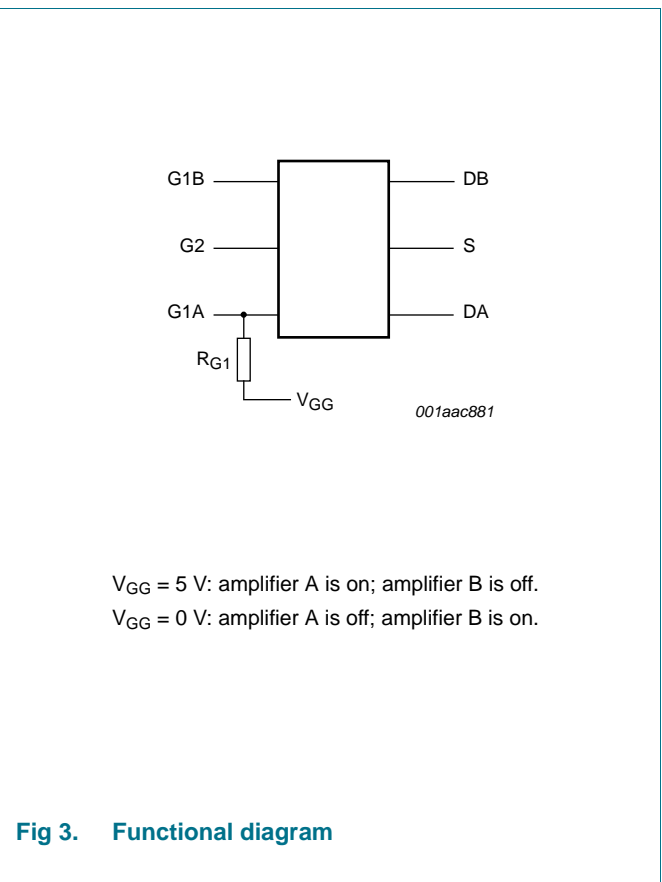
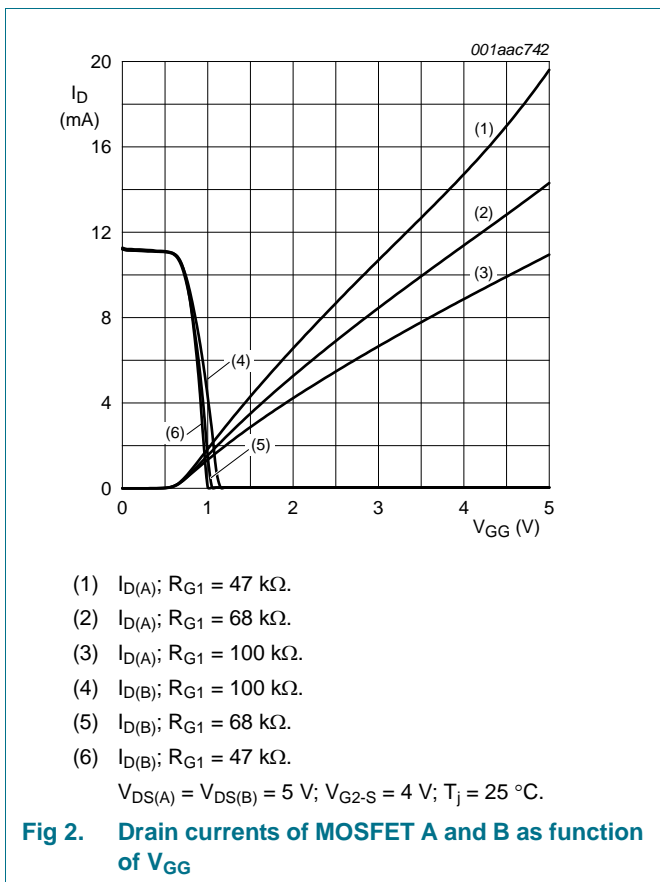

## 8. Dynamic characteristics

### 8.1 Dynamic characteristics for amplifier A

**Table 8. Dynamic characteristics for amplifier A**

Common source;  $T_{amb} = 25\text{ °C}$ ;  $V_{G2-S} = 4\text{ V}$ ;  $V_{DS} = 5\text{ V}$ ;  $I_D = 18\text{ mA}$ .<sup>[1]</sup>

Symbol	Parameter	Conditions	Min	Typ	Max	Unit
$ y_{fs} $	forward transfer admittance	$T_j = 25\text{ °C}$	25	30	40	mS
$C_{iss(G1)}$	input capacitance at gate1	$f = 100\text{ MHz}$	-	2.2	2.7	pF
$C_{iss(G2)}$	input capacitance at gate2	$f = 1\text{ MHz}$	-	3.5	-	pF
$C_{oss}$	output capacitance	$f = 100\text{ MHz}$	-	0.9	-	pF
$C_{rss}$	reverse transfer capacitance	$f = 100\text{ MHz}$	-	20	-	fF
$G_{tr}$	power gain	$B_S = B_{S(opt)}$ ; $B_L = B_{L(opt)}$				
		$f = 200\text{ MHz}$ ; $G_S = 2\text{ mS}$ ; $G_L = 0.5\text{ mS}$	30	34	38	dB
		$f = 400\text{ MHz}$ ; $G_S = 2\text{ mS}$ ; $G_L = 1\text{ mS}$	26	30	34	dB
		$f = 800\text{ MHz}$ ; $G_S = 3.3\text{ mS}$ ; $G_L = 1\text{ mS}$	21	25	29	dB
NF	noise figure	$f = 11\text{ MHz}$ ; $G_S = 20\text{ mS}$ ; $B_S = 0\text{ S}$	-	3.0	-	dB
		$f = 400\text{ MHz}$ ; $Y_S = Y_{S(opt)}$	-	1.3	-	dB
		$f = 800\text{ MHz}$ ; $Y_S = Y_{S(opt)}$	-	1.4	-	dB
Xmod	cross-modulation	input level for $k = 1\%$ ; $f_w = 50\text{ MHz}$ ; $f_{unw} = 60\text{ MHz}$				
		at 0 dB AGC	90	-	-	dB $\mu$ V
		at 10 dB AGC	-	90	-	dB $\mu$ V
		at 20 dB AGC	-	99	-	dB $\mu$ V
		at 40 dB AGC	100	105	-	dB $\mu$ V

[1] For the MOSFET not in use:  $V_{G1-S(B)} = 0\text{ V}$ ;  $V_{DS(B)} = 0\text{ V}$ .

[2] Measured in [Figure 29](#) test circuit.

**8.1.1 Graphs for amplifier A**

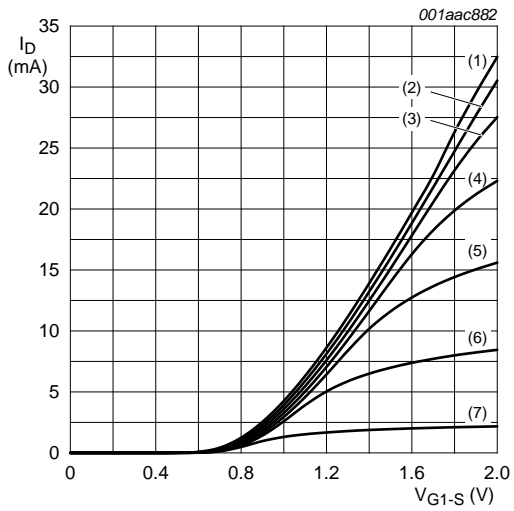

- (1)  $V_{G2-S} = 4 \text{ V}$ .
  - (2)  $V_{G2-S} = 3.5 \text{ V}$ .
  - (3)  $V_{G2-S} = 3 \text{ V}$ .
  - (4)  $V_{G2-S} = 2.5 \text{ V}$ .
  - (5)  $V_{G2-S} = 2 \text{ V}$ .
  - (6)  $V_{G2-S} = 1.5 \text{ V}$ .
  - (7)  $V_{G2-S} = 1 \text{ V}$ .
- $V_{DS(A)} = 5 \text{ V}; T_j = 25 \text{ }^\circ\text{C}$ .

**Fig 4. Amplifier A: transfer characteristics; typical values**

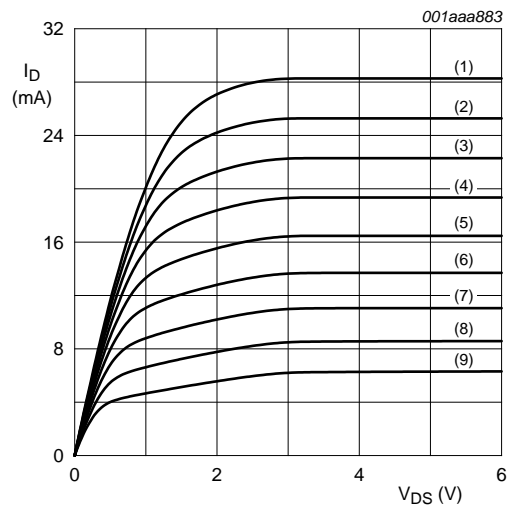

- (1)  $V_{G1-S(A)} = 1.9 \text{ V}$ .
  - (2)  $V_{G1-S(A)} = 1.8 \text{ V}$ .
  - (3)  $V_{G1-S(A)} = 1.7 \text{ V}$ .
  - (4)  $V_{G1-S(A)} = 1.6 \text{ V}$ .
  - (5)  $V_{G1-S(A)} = 1.5 \text{ V}$ .
  - (6)  $V_{G1-S(A)} = 1.4 \text{ V}$ .
  - (7)  $V_{G1-S(A)} = 1.3 \text{ V}$ .
  - (8)  $V_{G1-S(A)} = 1.2 \text{ V}$ .
  - (9)  $V_{G1-S(A)} = 1.1 \text{ V}$ .
- $V_{DS(A)} = 5 \text{ V}; V_{G2-S} = 4 \text{ V}; T_j = 25 \text{ }^\circ\text{C}$ .

**Fig 5. Amplifier A: output characteristics; typical values**

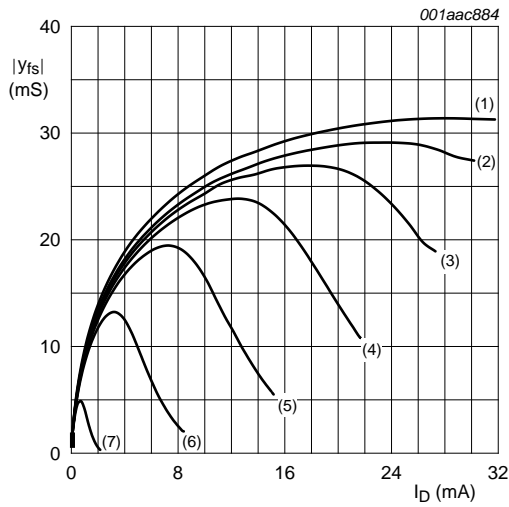

- (1)  $V_{G2-S} = 4 \text{ V}$ .
  - (2)  $V_{G2-S} = 3.5 \text{ V}$ .
  - (3)  $V_{G2-S} = 3 \text{ V}$ .
  - (4)  $V_{G2-S} = 2.5 \text{ V}$ .
  - (5)  $V_{G2-S} = 2 \text{ V}$ .
  - (6)  $V_{G2-S} = 1.5 \text{ V}$ .
  - (7)  $V_{G2-S} = 1 \text{ V}$ .
- $V_{DS(A)} = 5 \text{ V}; T_j = 25 \text{ }^\circ\text{C}$ .

**Fig 6. Amplifier A: forward transfer admittance as a function of drain current; typical values**

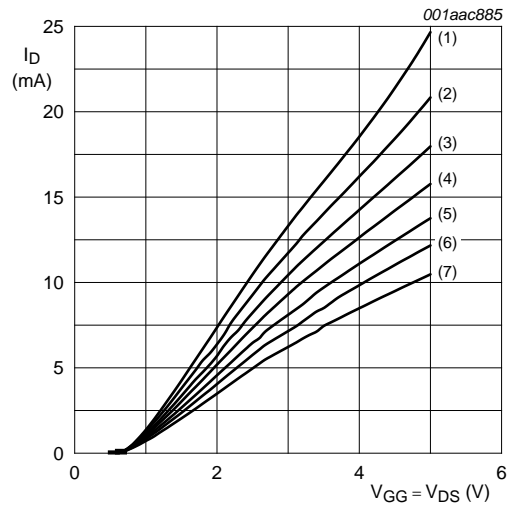

- (1)  $R_{G1(A)} = 39 \text{ k}\Omega$ .
  - (2)  $R_{G1(A)} = 47 \text{ k}\Omega$ .
  - (3)  $R_{G1(A)} = 68 \text{ k}\Omega$ .
  - (4)  $R_{G1(A)} = 82 \text{ k}\Omega$ .
  - (5)  $R_{G1(A)} = 100 \text{ k}\Omega$ .
  - (6)  $R_{G1(A)} = 120 \text{ k}\Omega$ .
  - (7)  $R_{G1(A)} = 150 \text{ k}\Omega$ .
- $V_{G2-S} = 4 \text{ V}; T_j = 25 \text{ }^\circ\text{C}$ .

**Fig 7. Amplifier A: drain current as a function of  $V_{DS}$  and  $V_{GG}$ ; typical values**

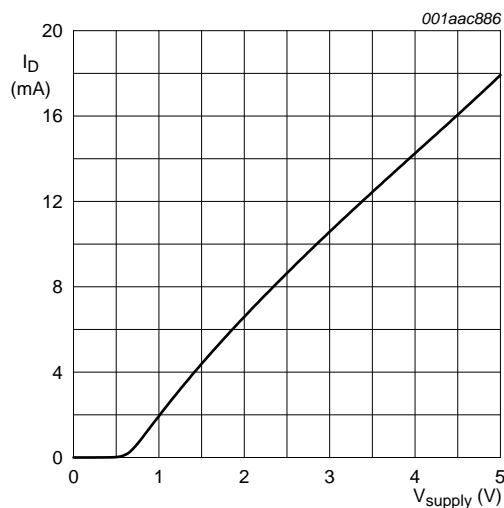

$V_{G2-S} = 4 \text{ V}, T_j = 25 \text{ }^\circ\text{C}, R_{G1(B)} = 68 \text{ k}\Omega$  (connected to ground); see [Figure 3](#).

**Fig 8. Amplifier A: drain current of amplifier A as a function of supply voltage of A and B amplifier; typical values**



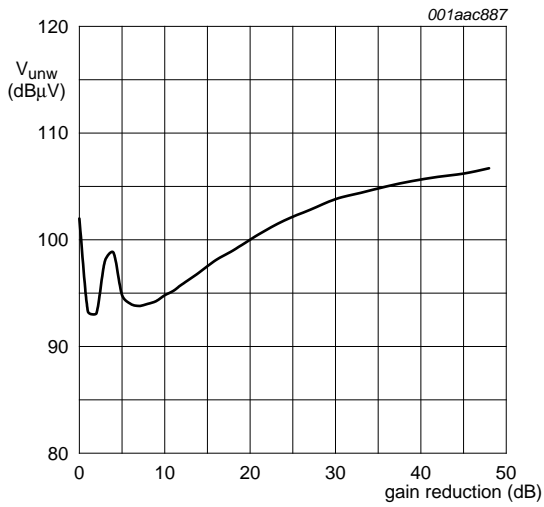

$V_{DS(A)} = V_{DS(B)} = 5\text{ V}$ ;  $V_{G1-S(B)} = 0\text{ V}$ ;  $f_w = 50\text{ MHz}$ ;  $f_{unw} = 60\text{ MHz}$ ;  $T_{amb} = 25\text{ °C}$ ; see [Figure 29](#).

**Fig 9. Amplifier A: unwanted voltage for 1 % cross-modulation as a function of gain reduction; typical values**

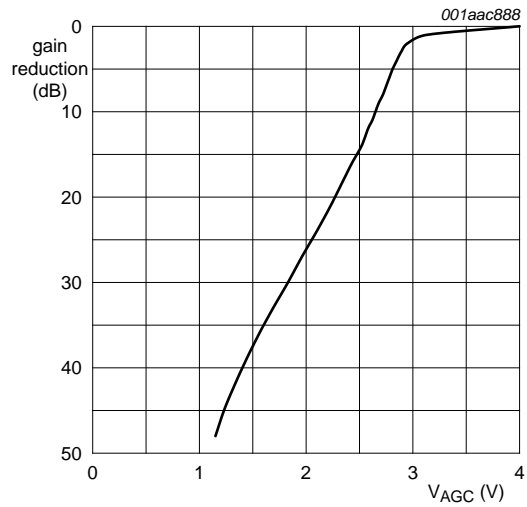

$V_{DS(A)} = V_{DS(B)} = 5\text{ V}$ ;  $V_{G1-S(B)} = 0\text{ V}$ ;  $f = 50\text{ MHz}$ ; see [Figure 29](#).

**Fig 10. Amplifier A: gain reduction as a function of AGC voltage; typical values**

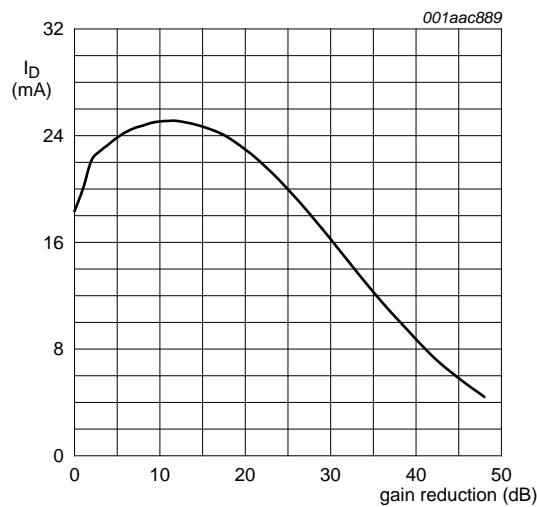

$V_{DS(A)} = V_{DS(B)} = 5\text{ V}$ ;  $V_{G1-S(B)} = 0\text{ V}$ ;  $f = 50\text{ MHz}$ ;  $T_{amb} = 25\text{ °C}$ ; see [Figure 29](#).

**Fig 11. Amplifier A: drain current as a function of gain reduction; typical values**

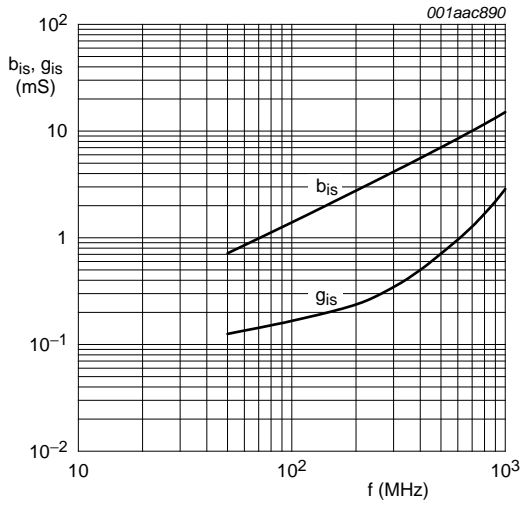

$V_{DS(A)} = 5\text{ V}; V_{G2-S} = 4\text{ V}; V_{DS(B)} = V_{G1-S(B)} = 0\text{ V}; I_{D(A)} = 18\text{ mA}.$

**Fig 12. Amplifier A: input admittance as a function of frequency; typical values**

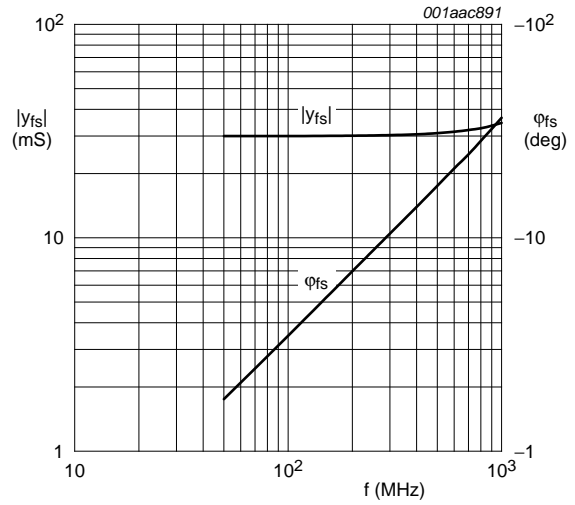

$V_{DS(A)} = 5\text{ V}; V_{G2-S} = 4\text{ V}; V_{DS(B)} = V_{G1-S(B)} = 0\text{ V}; I_{D(A)} = 18\text{ mA}.$

**Fig 13. Amplifier A: forward transfer admittance and phase as a function of frequency; typical values**

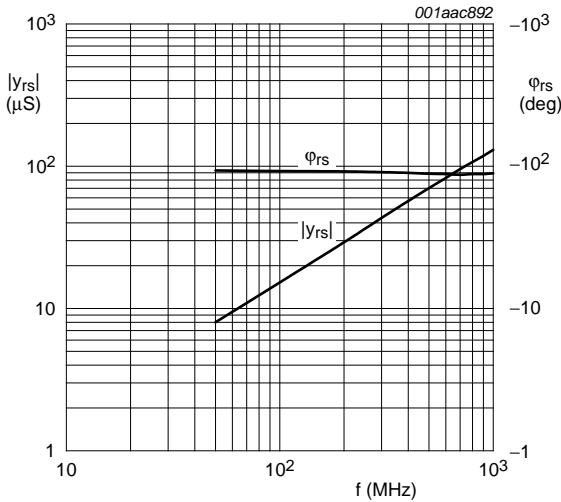

$V_{DS(A)} = 5\text{ V}; V_{G2-S} = 4\text{ V}; V_{DS(B)} = V_{G1-S(B)} = 0\text{ V}; I_{D(A)} = 18\text{ mA}.$

**Fig 14. Amplifier A: reverse transfer admittance and phase as a function of frequency: typical values**

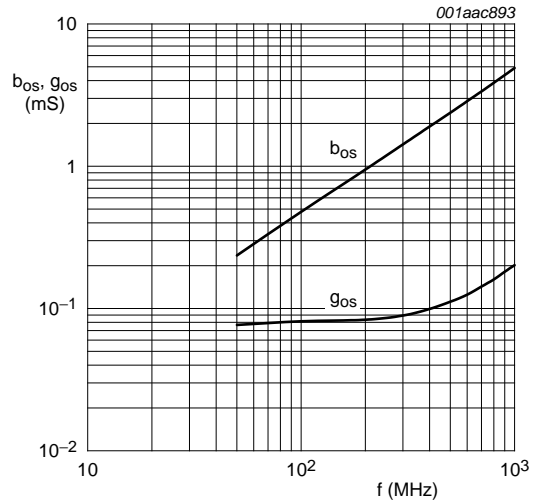

$V_{DS(A)} = 5\text{ V}; V_{G2-S} = 4\text{ V}; V_{DS(B)} = V_{G1-S(B)} = 0\text{ V}; I_{D(A)} = 18\text{ mA}.$

**Fig 15. Amplifier A: output admittance as a function of frequency; typical values**

## 8.1.2 Scattering parameters for amplifier A

Table 9. Scattering parameters for amplifier A

$V_{DS(A)} = 5\text{ V}$ ;  $V_{G2-S} = 4\text{ V}$ ;  $I_{D(A)} = 18\text{ mA}$ ;  $V_{DS(B)} = 0\text{ V}$ ;  $V_{G1-S(B)} = 0\text{ V}$ ;  $T_{amb} = 25\text{ °C}$ ; typical values.

f (MHz)	S <sub>11</sub>		S <sub>21</sub>		S <sub>12</sub>		S <sub>22</sub>	
	Magnitude (ratio)	Angle (deg)	Magnitude (ratio)	Angle (deg)	Magnitude (ratio)	Angle (deg)	Magnitude (ratio)	Angle (deg)
50	0.987	-4.169	2.87	175.5	0.0008	83.82	0.992	-1.42
100	0.983	-8.109	2.95	171.14	0.0015	82.08	0.992	-2.86
200	0.976	-15.97	2.93	162.44	0.0028	77.50	0.990	-5.66
300	0.966	-23.844	2.89	153.77	0.0041	73.45	0.989	-8.49
400	0.952	-31.575	2.84	145.23	0.0053	69.42	0.986	-11.28
500	0.935	-35.225	2.78	136.82	0.0063	65.72	0.984	-14.03
600	0.917	-46.678	2.72	128.50	0.0072	61.48	0.981	-16.80
700	0.898	-54.094	2.65	120.44	0.0079	58.05	0.977	-19.55
800	0.876	-61.205	2.57	112.33	0.0084	52.74	0.974	-22.32
900	0.852	-68.299	2.49	104.32	0.0089	48.61	0.970	-25.10
1000	0.826	-75.321	2.41	96.42	0.0091	43.86	0.967	-27.88

## 8.2 Dynamic characteristics for amplifier B

**Table 10. Dynamic characteristics for amplifier B**

Common source;  $T_{amb} = 25\text{ °C}$ ;  $V_{G2-S} = 4\text{ V}$ ;  $V_{DS} = 5\text{ V}$ ;  $I_D = 14\text{ mA}$ .<sup>[1]</sup>

Symbol	Parameter	Conditions	Min	Typ	Max	Unit
$ y_{fs} $	forward transfer admittance	$T_j = 25\text{ °C}$	26	31	41	mS
$C_{iss(G1)}$	input capacitance at gate1	$f = 100\text{ MHz}$	-	1.8	2.3	pF
$C_{iss(G2)}$	input capacitance at gate2	$f = 1\text{ MHz}$	-	3.5	-	pF
$C_{oss}$	output capacitance	$f = 100\text{ MHz}$	-	0.8	-	pF
$C_{rss}$	reverse transfer capacitance	$f = 100\text{ MHz}$	-	20	-	fF
$G_{tr}$	power gain	$B_S = B_{S(opt)}$ ; $B_L = B_{L(opt)}$				
		$f = 200\text{ MHz}$ ; $G_S = 2\text{ mS}$ ; $G_L = 0.5\text{ mS}$	30	34	38	dB
		$f = 400\text{ MHz}$ ; $G_S = 2\text{ mS}$ ; $G_L = 1\text{ mS}$	27	31	35	dB
		$f = 800\text{ MHz}$ ; $G_S = 3.3\text{ mS}$ ; $G_L = 1\text{ mS}$	23	27	31	dB
NF	noise figure	$f = 11\text{ MHz}$ ; $G_S = 20\text{ mS}$ ; $B_S = 0\text{ S}$	-	5	-	dB
		$f = 400\text{ MHz}$ ; $Y_S = Y_{S(opt)}$	-	1.3	-	dB
		$f = 800\text{ MHz}$ ; $Y_S = Y_{S(opt)}$	-	1.4	-	dB
Xmod	cross-modulation	input level for $k = 1\%$ ; $f_w = 50\text{ MHz}$ ; $f_{unw} = 60\text{ MHz}$ <sup>[2]</sup>				
		at 0 dB AGC	90	-	-	dB $\mu$ V
		at 10 dB AGC	-	88	-	dB $\mu$ V
		at 20 dB AGC	-	94	-	dB $\mu$ V
		at 40 dB AGC	100	103	-	dB $\mu$ V

[1] For the MOSFET not in use:  $V_{G1-S(A)} = 0\text{ V}$ ;  $V_{DS(A)} = 0\text{ V}$ .

[2] Measured in [Figure 30](#) test circuit.

**8.2.1 Graphs for amplifier B**

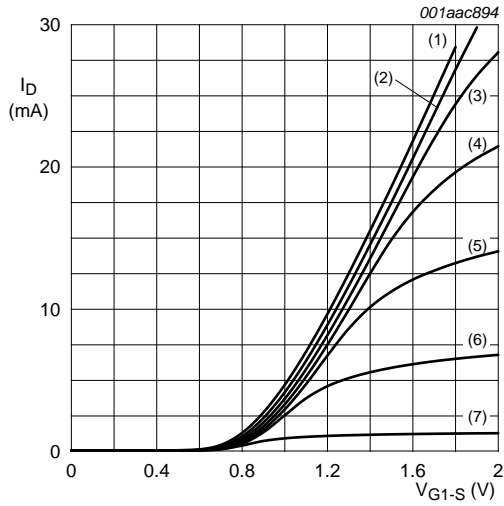

- (1)  $V_{G2-S} = 4 \text{ V}$ .
- (2)  $V_{G2-S} = 3.5 \text{ V}$ .
- (3)  $V_{G2-S} = 3 \text{ V}$ .
- (4)  $V_{G2-S} = 2.5 \text{ V}$ .
- (5)  $V_{G2-S} = 2 \text{ V}$ .
- (6)  $V_{G2-S} = 1.5 \text{ V}$ .
- (7)  $V_{G2-S} = 1 \text{ V}$ .

$V_{DS(B)} = 5 \text{ V}$ ;  $V_{G1-S(A)} = 0 \text{ V}$ ;  $T_j = 25 \text{ }^\circ\text{C}$ .

**Fig 16. Amplifier B: transfer characteristics; typical values**

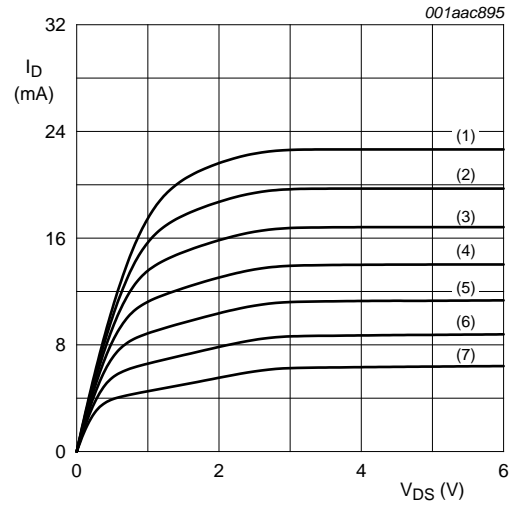

- (1)  $V_{G1-S(B)} = 1.7 \text{ V}$ .
- (2)  $V_{G1-S(B)} = 1.6 \text{ V}$ .
- (3)  $V_{G1-S(B)} = 1.5 \text{ V}$ .
- (4)  $V_{G1-S(B)} = 1.4 \text{ V}$ .
- (5)  $V_{G1-S(B)} = 1.3 \text{ V}$ .
- (6)  $V_{G1-S(B)} = 1.2 \text{ V}$ .
- (7)  $V_{G1-S(B)} = 1.1 \text{ V}$ .

$V_{G2-S} = 4 \text{ V}$ ;  $V_{G1-S(A)} = 0 \text{ V}$ ;  $T_j = 25 \text{ }^\circ\text{C}$ .

**Fig 17. Amplifier B: output characteristics; typical values**

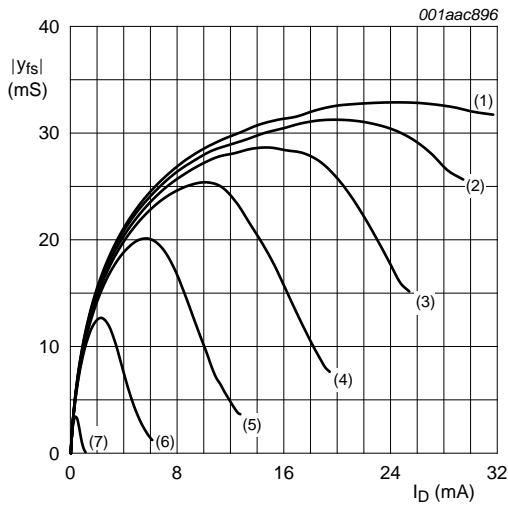

- (1)  $V_{G2-S} = 4 \text{ V}$ .
  - (2)  $V_{G2-S} = 3.5 \text{ V}$ .
  - (3)  $V_{G2-S} = 3 \text{ V}$ .
  - (4)  $V_{G2-S} = 2.5 \text{ V}$ .
  - (5)  $V_{G2-S} = 2 \text{ V}$ .
  - (6)  $V_{G2-S} = 1.5 \text{ V}$ .
  - (7)  $V_{G2-S} = 1 \text{ V}$ .
- $V_{DS(B)} = 5 \text{ V}; V_{G1-S(A)} = 0 \text{ V}; T_j = 25 \text{ }^\circ\text{C}$ .

**Fig 18. Amplifier B: forward transfer admittance as a function of drain current; typical values**

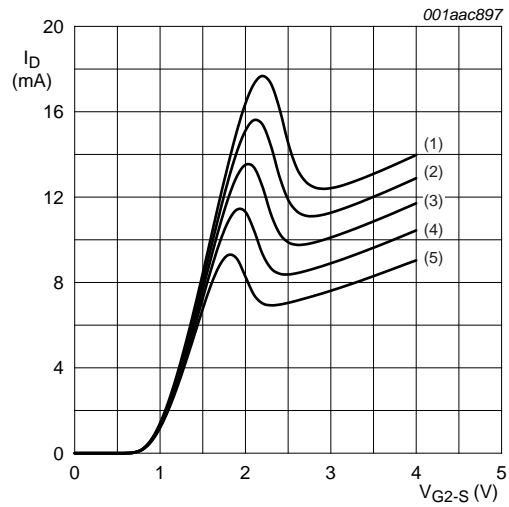

- (1)  $V_{DS} = 5 \text{ V}$ .
  - (2)  $V_{DS} = 4.5 \text{ V}$ .
  - (3)  $V_{DS} = 4 \text{ V}$ .
  - (4)  $V_{DS} = 3.5 \text{ V}$ .
  - (5)  $V_{DS} = 3 \text{ V}$ .
- $V_{G1-S(A)} = 0 \text{ V}; T_j = 25 \text{ }^\circ\text{C}$ .

**Fig 19. Amplifier B: drain current as function of gate2 voltage; typical values**

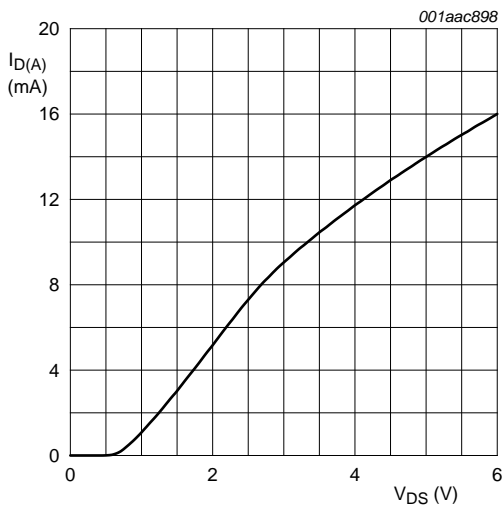

$V_{DS(B)} = 5 \text{ V}; V_{G1-S(A)} = 0 \text{ V}; T_j = 25 \text{ }^\circ\text{C}$ .

**Fig 20. Amplifier B: drain current as a function of drain source voltage; typical values**

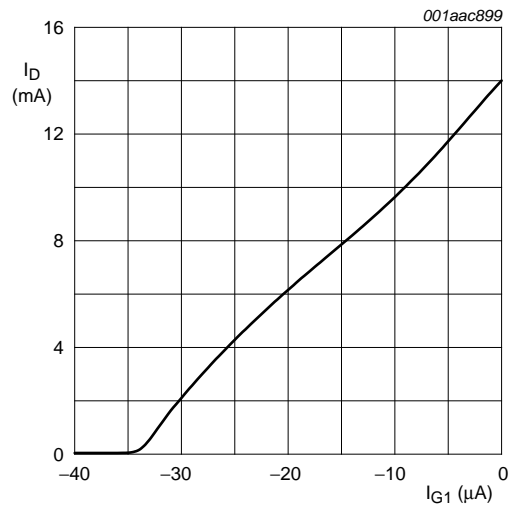

$V_{DS(B)} = 5 \text{ V}; V_{G2-S} = 4 \text{ V}; V_{G1-S(A)} = 0 \text{ V}; T_j = 25 \text{ }^\circ\text{C}$ .

**Fig 21. Amplifier B: drain current as a function of gate1 current; typical values**

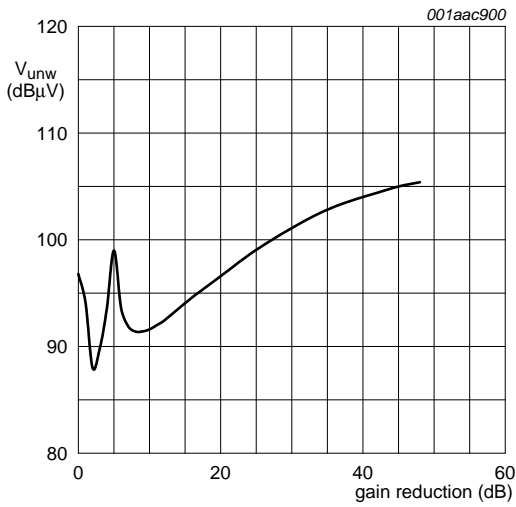

$V_{DS(B)} = 5\text{ V}$ ;  $V_{GG} = 5\text{ V}$ ;  $V_{DS(A)} = V_{G1-S(A)} = 0\text{ V}$ ;  
 $R_{G1(B)} = 150\text{ k}\Omega$  (connected to  $V_{GG}$ );  $f_w = 50\text{ MHz}$ ;  
 $f_{unw} = 60\text{ MHz}$ ;  $T_{amb} = 25\text{ }^\circ\text{C}$ ; see [Figure 30](#).

**Fig 22. Amplifier B: unwanted voltage for 1 % cross-modulation as a function of gain reduction; typical values**

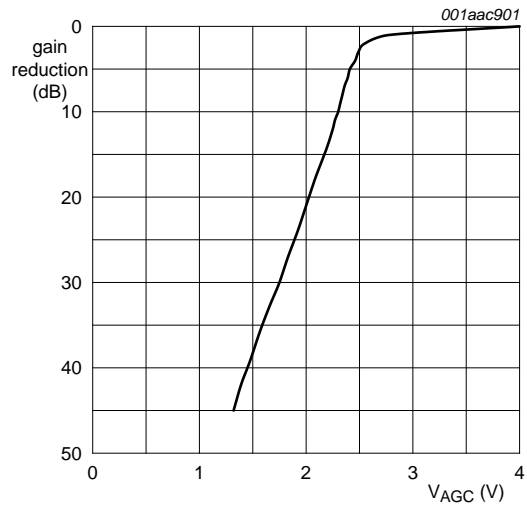

$V_{DS(B)} = 5\text{ V}$ ;  $V_{GG} = 5\text{ V}$ ;  $V_{DS(A)} = V_{G1-S(A)} = 0\text{ V}$ ;  
 $R_{G1(B)} = 150\text{ k}\Omega$  (connected to  $V_{GG}$ );  $f = 50\text{ MHz}$ ;  
 $T_{amb} = 25\text{ }^\circ\text{C}$ ; see [Figure 30](#).

**Fig 23. Amplifier B: typical gain reduction as a function of AGC voltage; typical values**

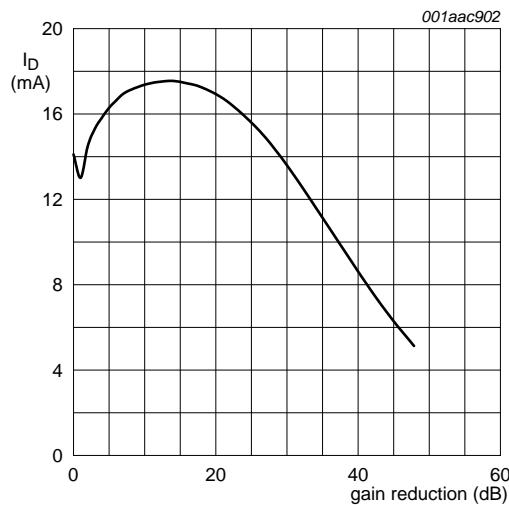

$V_{DS(B)} = 5\text{ V}$ ;  $V_{GG} = 5\text{ V}$ ;  $V_{DS(A)} = V_{G1-S(A)} = 0\text{ V}$ ;  $R_{G1(B)} = 150\text{ k}\Omega$  (connected to  $V_{GG}$ );  $f = 50\text{ MHz}$ ;  $T_{amb} = 25\text{ }^\circ\text{C}$ ; see [Figure 30](#).

**Fig 24. Amplifier B: drain current as a function of gain reduction; typical values**

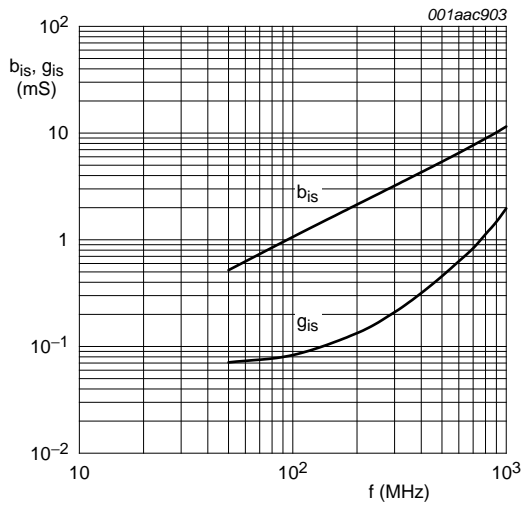

$V_{DS(B)} = 5\text{ V}; V_{G2-S} = 4\text{ V}; V_{DS(A)} = V_{G1-S(A)} = 0\text{ V}; I_{D(B)} = 14\text{ mA}$ .

**Fig 25. Amplifier B: input admittance as a function of frequency; typical values**

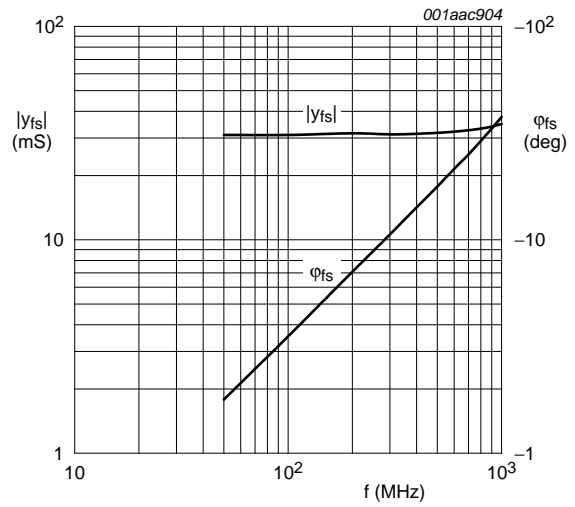

$V_{DS(B)} = 5\text{ V}; V_{G2-S} = 4\text{ V}; V_{DS(A)} = V_{G1-S(A)} = 0\text{ V}; I_{D(B)} = 14\text{ mA}$ .

**Fig 26. Amplifier B: forward transfer admittance and phase as a function of frequency; typical values**

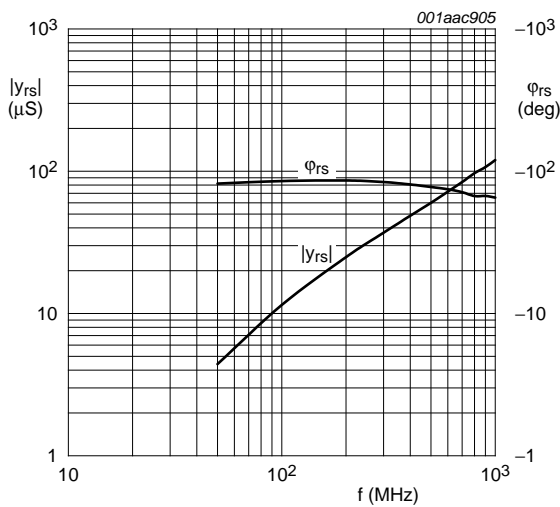

$V_{DS(B)} = 5\text{ V}; V_{G2-S} = 4\text{ V}; V_{DS(A)} = V_{G1-S(A)} = 0\text{ V}; I_{D(B)} = 14\text{ mA}$ .

**Fig 27. Amplifier B: reverse transfer admittance and phase as a function of frequency; typical values**

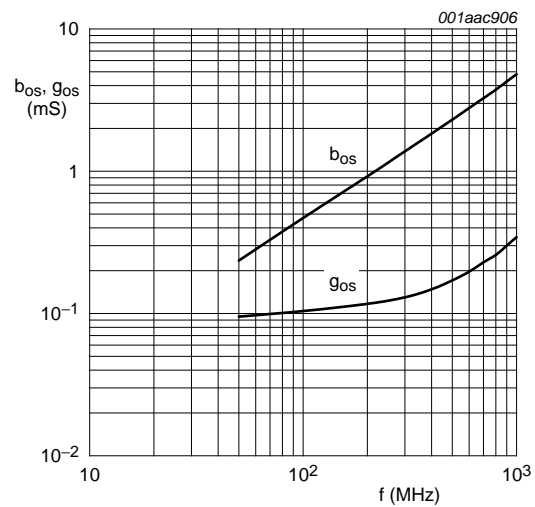

$V_{DS(B)} = 5\text{ V}; V_{G2-S} = 4\text{ V}; V_{DS(A)} = V_{G1-S(A)} = 0\text{ V}; I_{D(B)} = 14\text{ mA}$ .

**Fig 28. Amplifier B: output admittance as a function of frequency; typical values**



## 8.2.2 Scattering parameters for amplifier B

**Table 11. Scattering parameters for amplifier B**

$V_{DS(B)} = 5\text{ V}$ ;  $V_{G2-S} = 4\text{ V}$ ;  $I_{D(B)} = 14\text{ mA}$ ;  $V_{DS(A)} = 0\text{ V}$ ;  $V_{G1-S(A)} = 0\text{ V}$ ;  $T_{amb} = 25\text{ °C}$ ; typical values.

f (MHz)	S <sub>11</sub>		S <sub>21</sub>		S <sub>12</sub>		S <sub>22</sub>	
	Magnitude (ratio)	Angle (deg)	Magnitude (ratio)	Angle (deg)	Magnitude (ratio)	Angle (deg)	Magnitude (ratio)	Angle (deg)
50	0.993	-3.018	3.07	176.04	0.0004	95.97	0.991	-1.39
100	0.992	-6.186	3.07	172.05	0.0011	90.33	0.990	-2.79
200	0.987	-12.43	3.09	164.13	0.0024	85.03	0.988	-5.49
300	0.979	-18.60	3.02	156.28	0.0036	82.94	0.986	-8.21
400	0.969	-24.62	2.99	148.48	0.0046	81.97	0.983	-10.91
500	0.957	-30.72	2.95	140.69	0.0056	81.03	0.980	-13.63
600	0.943	-36.71	2.90	132.87	0.0065	79.77	0.977	-16.40
700	0.927	-42.77	2.86	125.21	0.0074	79.04	0.973	-19.13
800	0.907	-48.91	2.79	117.22	0.0082	79.42	0.969	-21.93
900	0.885	-54.77	2.736	109.29	0.0086	75.47	0.964	-24.85
1000	0.858	-61.01	2.675	101.18	0.0092	73.48	0.958	-27.75

**9. Test information**

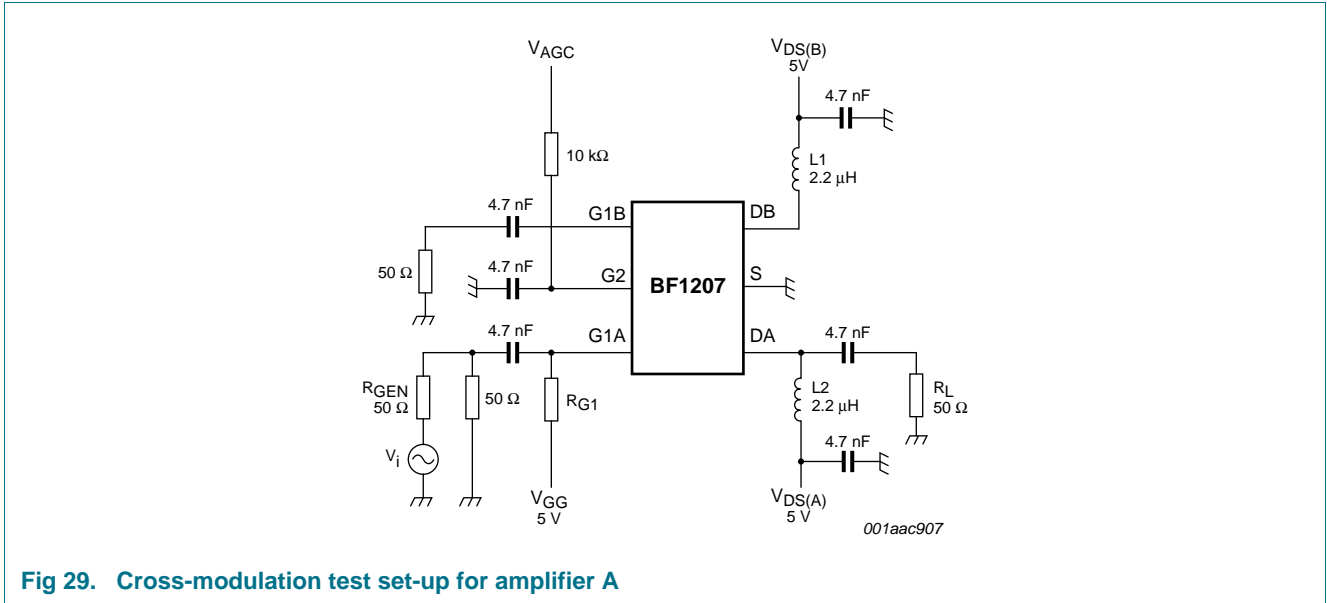

**Fig 29. Cross-modulation test set-up for amplifier A**

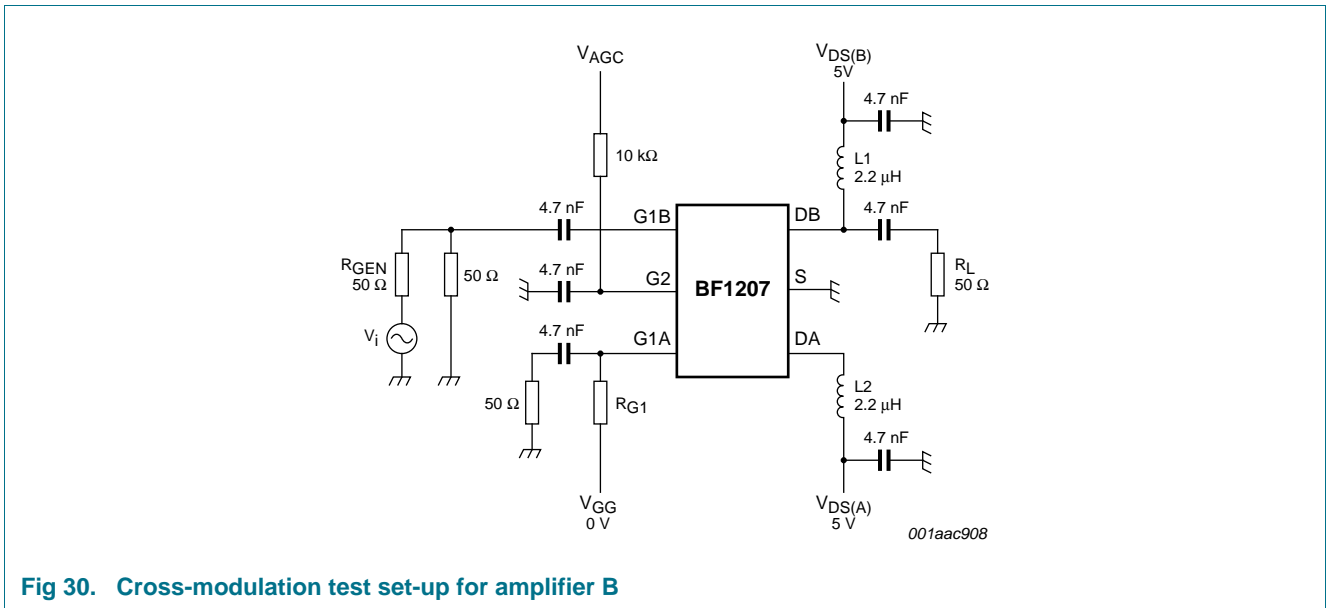
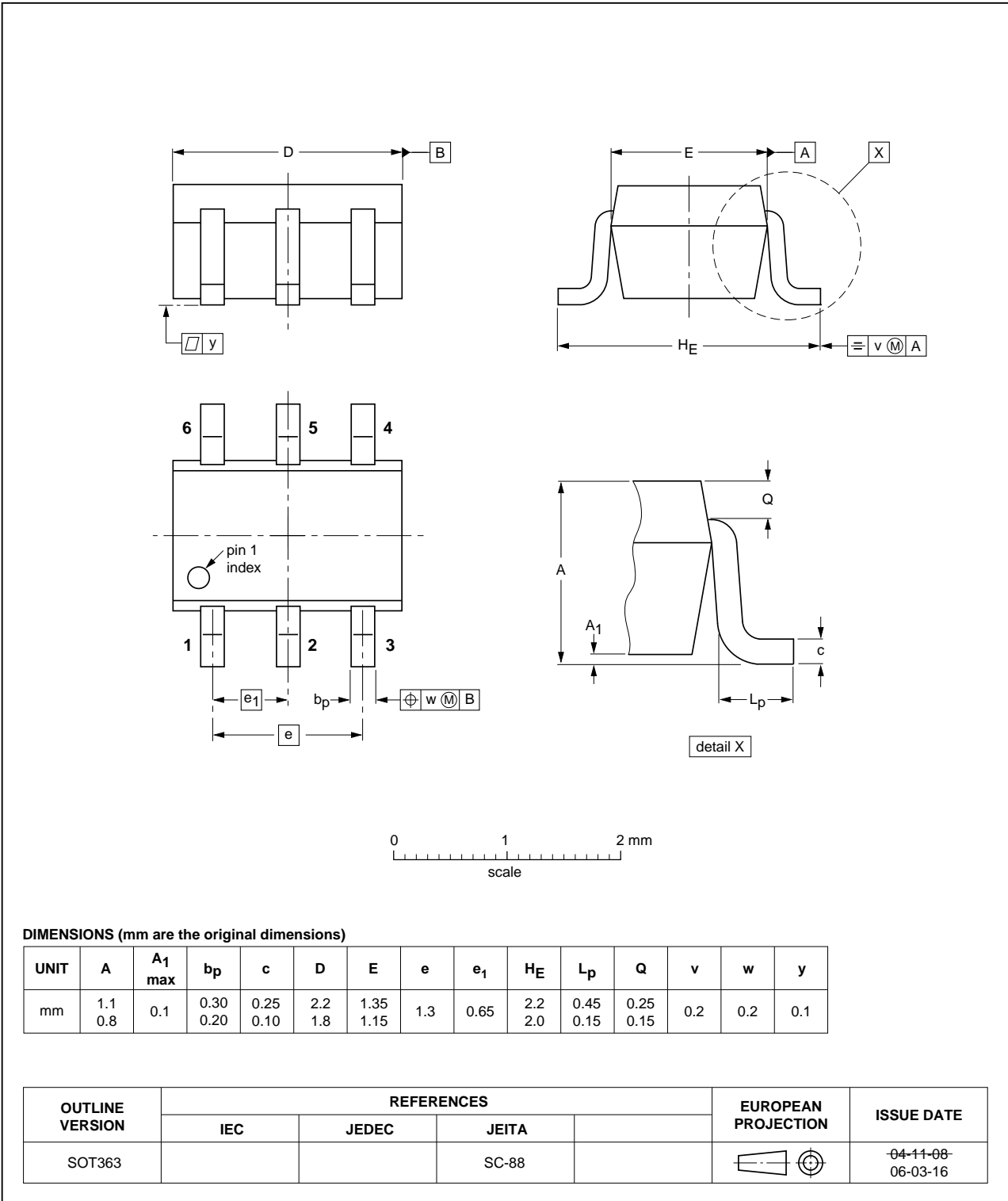

**Fig 30. Cross-modulation test set-up for amplifier B**

**10. Package outline**

Plastic surface-mounted package; 6 leads

SOT363



**Fig 31. Package outline SOT363**

## 11. Revision history

Table 12. Revision history

Document ID	Release date	Data sheet status	Change notice	Supersedes
BF1207 v.2	20110907	Product data sheet	-	BF1207 v.1
Modifications:		<ul style="list-style-type: none"><li>• The format of this data sheet has been redesigned to comply with the new identity guidelines of NXP Semiconductors.</li><li>• Legal texts have been adapted to the new company name where appropriate.</li><li>• Package outline drawings have been updated to the latest version.</li></ul>		
BF1207 v.1 (9397 750 14955)	20050728	Product data sheet	-	-

## 12. Legal information

### 12.1 Data sheet status

Document status <sup>[1][2]</sup>	Product status <sup>[3]</sup>	Definition
Objective [short] data sheet	Development	This document contains data from the objective specification for product development.
Preliminary [short] data sheet	Qualification	This document contains data from the preliminary specification.
Product [short] data sheet	Production	This document contains the product specification.

[1] Please consult the most recently issued document before initiating or completing a design.

[2] The term 'short data sheet' is explained in section "Definitions".

[3] The product status of device(s) described in this document may have changed since this document was published and may differ in case of multiple devices. The latest product status information is available on the Internet at URL <http://www.nxp.com>.

### 12.2 Definitions

**Draft** — The document is a draft version only. The content is still under internal review and subject to formal approval, which may result in modifications or additions. NXP Semiconductors does not give any representations or warranties as to the accuracy or completeness of information included herein and shall have no liability for the consequences of use of such information.

**Short data sheet** — A short data sheet is an extract from a full data sheet with the same product type number(s) and title. A short data sheet is intended for quick reference only and should not be relied upon to contain detailed and full information. For detailed and full information see the relevant full data sheet, which is available on request via the local NXP Semiconductors sales office. In case of any inconsistency or conflict with the short data sheet, the full data sheet shall prevail.

**Product specification** — The information and data provided in a Product data sheet shall define the specification of the product as agreed between NXP Semiconductors and its customer, unless NXP Semiconductors and customer have explicitly agreed otherwise in writing. In no event however, shall an agreement be valid in which the NXP Semiconductors product is deemed to offer functions and qualities beyond those described in the Product data sheet.

### 12.3 Disclaimers

**Limited warranty and liability** — Information in this document is believed to be accurate and reliable. However, NXP Semiconductors does not give any representations or warranties, expressed or implied, as to the accuracy or completeness of such information and shall have no liability for the consequences of use of such information.

In no event shall NXP Semiconductors be liable for any indirect, incidental, punitive, special or consequential damages (including - without limitation - lost profits, lost savings, business interruption, costs related to the removal or replacement of any products or rework charges) whether or not such damages are based on tort (including negligence), warranty, breach of contract or any other legal theory.

Notwithstanding any damages that customer might incur for any reason whatsoever, NXP Semiconductors' aggregate and cumulative liability towards customer for the products described herein shall be limited in accordance with the *Terms and conditions of commercial sale* of NXP Semiconductors.

**Right to make changes** — NXP Semiconductors reserves the right to make changes to information published in this document, including without limitation specifications and product descriptions, at any time and without notice. This document supersedes and replaces all information supplied prior to the publication hereof.

**Suitability for use** — NXP Semiconductors products are not designed, authorized or warranted to be suitable for use in life support, life-critical or safety-critical systems or equipment, nor in applications where failure or

malfunction of an NXP Semiconductors product can reasonably be expected to result in personal injury, death or severe property or environmental damage. NXP Semiconductors accepts no liability for inclusion and/or use of NXP Semiconductors products in such equipment or applications and therefore such inclusion and/or use is at the customer's own risk.

**Applications** — Applications that are described herein for any of these products are for illustrative purposes only. NXP Semiconductors makes no representation or warranty that such applications will be suitable for the specified use without further testing or modification.

Customers are responsible for the design and operation of their applications and products using NXP Semiconductors products, and NXP Semiconductors accepts no liability for any assistance with applications or customer product design. It is customer's sole responsibility to determine whether the NXP Semiconductors product is suitable and fit for the customer's applications and products planned, as well as for the planned application and use of customer's third party customer(s). Customers should provide appropriate design and operating safeguards to minimize the risks associated with their applications and products.

NXP Semiconductors does not accept any liability related to any default, damage, costs or problem which is based on any weakness or default in the customer's applications or products, or the application or use by customer's third party customer(s). Customer is responsible for doing all necessary testing for the customer's applications and products using NXP Semiconductors products in order to avoid a default of the applications and the products or of the application or use by customer's third party customer(s). NXP does not accept any liability in this respect.

**Limiting values** — Stress above one or more limiting values (as defined in the Absolute Maximum Ratings System of IEC 60134) will cause permanent damage to the device. Limiting values are stress ratings only and (proper) operation of the device at these or any other conditions above those given in the Recommended operating conditions section (if present) or the Characteristics sections of this document is not warranted. Constant or repeated exposure to limiting values will permanently and irreversibly affect the quality and reliability of the device.

**Terms and conditions of commercial sale** — NXP Semiconductors products are sold subject to the general terms and conditions of commercial sale, as published at <http://www.nxp.com/profile/terms>, unless otherwise agreed in a valid written individual agreement. In case an individual agreement is concluded only the terms and conditions of the respective agreement shall apply. NXP Semiconductors hereby expressly objects to applying the customer's general terms and conditions with regard to the purchase of NXP Semiconductors products by customer.

**No offer to sell or license** — Nothing in this document may be interpreted or construed as an offer to sell products that is open for acceptance or the grant, conveyance or implication of any license under any copyrights, patents or other industrial or intellectual property rights.

**Export control** — This document as well as the item(s) described herein may be subject to export control regulations. Export might require a prior authorization from national authorities.

**Quick reference data** — The Quick reference data is an extract of the product data given in the Limiting values and Characteristics sections of this document, and as such is not complete, exhaustive or legally binding.

**Non-automotive qualified products** — Unless this data sheet expressly states that this specific NXP Semiconductors product is automotive qualified, the product is not suitable for automotive use. It is neither qualified nor tested in accordance with automotive testing or application requirements. NXP Semiconductors accepts no liability for inclusion and/or use of non-automotive qualified products in automotive equipment or applications.

In the event that customer uses the product for design-in and use in automotive applications to automotive specifications and standards, customer (a) shall use the product without NXP Semiconductors' warranty of the

product for such automotive applications, use and specifications, and (b) whenever customer uses the product for automotive applications beyond NXP Semiconductors' specifications such use shall be solely at customer's own risk, and (c) customer fully indemnifies NXP Semiconductors for any liability, damages or failed product claims resulting from customer design and use of the product for automotive applications beyond NXP Semiconductors' standard warranty and NXP Semiconductors' product specifications.

## 12.4 Trademarks

Notice: All referenced brands, product names, service names and trademarks are the property of their respective owners.

## 13. Contact information

For more information, please visit: <http://www.nxp.com>

For sales office addresses, please send an email to: [salesaddresses@nxp.com](mailto:salesaddresses@nxp.com)

## 14. Contents

<b>1</b>	<b>Product profile</b> . . . . .	<b>1</b>
1.1	General description . . . . .	1
1.2	Features and benefits . . . . .	1
1.3	Applications . . . . .	1
1.4	Quick reference data . . . . .	2
<b>2</b>	<b>Pinning information</b> . . . . .	<b>2</b>
<b>3</b>	<b>Ordering information</b> . . . . .	<b>3</b>
<b>4</b>	<b>Marking</b> . . . . .	<b>3</b>
<b>5</b>	<b>Limiting values</b> . . . . .	<b>3</b>
<b>6</b>	<b>Thermal characteristics</b> . . . . .	<b>4</b>
<b>7</b>	<b>Static characteristics</b> . . . . .	<b>4</b>
<b>8</b>	<b>Dynamic characteristics</b> . . . . .	<b>6</b>
8.1	Dynamic characteristics for amplifier A . . . . .	6
8.1.1	Graphs for amplifier A . . . . .	7
8.1.2	Scattering parameters for amplifier A . . . . .	11
8.2	Dynamic characteristics for amplifier B . . . . .	12
8.2.1	Graphs for amplifier B . . . . .	13
8.2.2	Scattering parameters for amplifier B . . . . .	17
<b>9</b>	<b>Test information</b> . . . . .	<b>18</b>
<b>10</b>	<b>Package outline</b> . . . . .	<b>19</b>
<b>11</b>	<b>Revision history</b> . . . . .	<b>20</b>
<b>12</b>	<b>Legal information</b> . . . . .	<b>21</b>
12.1	Data sheet status . . . . .	21
12.2	Definitions . . . . .	21
12.3	Disclaimers . . . . .	21
12.4	Trademarks . . . . .	22
<b>13</b>	<b>Contact information</b> . . . . .	<b>22</b>
<b>14</b>	<b>Contents</b> . . . . .	<b>23</b>

Please be aware that important notices concerning this document and the product(s) described herein, have been included in section 'Legal information'.

© NXP B.V. 2011.

All rights reserved.

For more information, please visit: <http://www.nxp.com>

For sales office addresses, please send an email to: [salesaddresses@nxp.com](mailto:salesaddresses@nxp.com)

Date of release: 7 September 2011

Document identifier: BF1207